

PHOTOVOLTAIC MODULES

EN

Installation manual

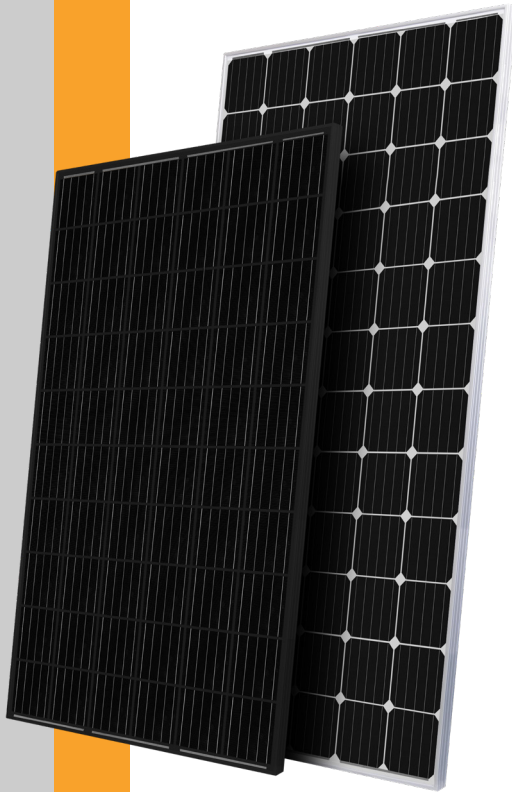

 SOLARCALL



It is specified that the technical data, information and representations reported in this document maintain a purely indicative value. Peimar reserves the right to modify the data, drawings and information contained in this document at any time and without notice.

1. Warning	4
2. Introduction	4
3. Applications	4
4. Codes And Regulations	4
5. Mechanical Installation	5
5.1. Mounting site	5
5.2. Orientation of installations	5
5.3. Module tilt angle	5
5.4. Mounting	6
5.4.1. Mounting using bolt holes	6
5.4.2. Mounting using “clamping method” and profile insert	7
6. Electrical Installation	10
6.1. Blocking diodes	10
6.2. Over current protection	10
6.3. Grounding	11
6.4. Wiring	12
7. Maintenance	13
8. Safety Precautions	13
9. Disposal	15
10. Notes	15

1. Warning

Please read this manual completely before installing solar module. This module produces electricity when exposed to light. Follow all applicable electrical safety precautions. Only licensed contractor can install or perform maintenance work on this module. Do not handle modules when they are wet.

2. Introduction

Solar modules come in various sizes to satisfy a full range of applications. Each module is made of crystalline-silicon cells. To protect the cells from the most severe-environmental conditions, modules are made of high transmission rate and low iron tempered glass, anti-aging encapsulation material, and high climate resistant and insulation back sheet by hot lamination, with anodized aluminum alloy frame and junction box.

3. Applications

Modules are reliable, virtually maintenance free power supply, designed to operate efficiently in sunlight. By modules, the solar radiant energy is transformed into electrical energy for using. Modules, usually be used as one fittings of PV solar system. A set of basic PV solar system is consisted of PV solar module, controller, inverter, and storage battery.

Modules can be used in roof PV solar systems, PV stations, building, and other electric generation application etc widely.

Application Class is Class A.

Modules rated for use in this application class may be used in systems operating at greater than 50VDC or 240W, where general contact access is anticipated. Modules qualified for safety through this part of IEC61730-1 and IEC61730-2 and within this application class are considered to meet the requirements for safety class II.

4. Codes And Regulations

The mechanical and electrical installation of PV systems should be performed in accordance with all applicable codes; including electrical codes, building coded, and electric utility interconnect requirements. Requirements may also vary with system voltage, and for DC or AC application.

5. Mechanical Installation

5.1. Mounting site

Modules can be used on land except for corrosive salt area and sulfurous area. Excluded applications include, but are not limited to, installations where modules are likely to come in contact with any salt water or where likely to become partially or wholly submerged in fresh or salt water, examples of which include use on boats, docks and buoys. Don't install modules in a location where it would be immersed in water or continually exposed to water from a sprinkler or fountain etc.

Modules are designed for a maximum allowable design pressure of 113 pounds per square foot, about 5400Pa, which may correspond to a nominal wind speed of approximately 130 km/h in certain circumstances.

Actual maximum allowable wind speed may be influenced by module type, mounting configuration, location, and other factors. In no case should modules be exposed to pressures greater than 113 pounds per square foot of uniformly distributed wind, snow, or other loading.

Not install modules near naked flame or flammable materials.

When choosing a site, avoid trees, buildings or obstructions. Modules should be mounted to maximize direct exposure to sunlight and to eliminate or minimize shadowing. Even partial shadowing can substantially reduce module and system output. Furthermore, partial shadowing can elevate the shaded portion internal temperature, which may lower output and shorten module life.

5.2. Orientation of installations

Modules may be mounted at any angle from a vertical orientation to a horizontal one. The appropriate fixed tilt angle and azimuth orientation should be used in order to maximize the exposure to sunlight.

Incorrect orientation of modules installation will result in loss of power output. Modules connected in series should be installed at same orientation and angle. Different orientation or angle may cause loss of power output due to difference of amount of sunlight exposed to the modules.

In the Northern Hemisphere, modules should face south, and in the Southern Hemisphere, modules should face north.

5.3. Module tilt angle

Modules produce the most power when they are pointed directly at the sun. For installations where modules are mounted to a permanent structure, modules should be titled for optimum winter performance. As a rule, if the PV system power production is adequate in the winter. It will be satisfactory during the rest of the year. The module tilt angle is measured between the modules and the ground.

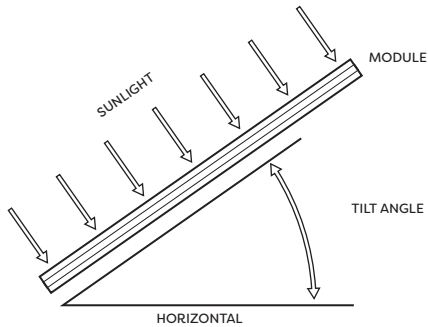

5.4. Mounting

Mounting support structure should withstand forces from wind and snowfall pressure etc. Mounting support structure should use proper materials and corrosive treatment.

Installation the modules should has proper ventilation. A clearance of 4.5 inches (about 115 mm) or more behind the modules is recommended to permit air circulation and cooler module operation. Elevated temperatures lower operating voltage and power, and shorten module lifetime. Clearance of 1/4 inch (6.35mm) or more between modules is required to allow for thermal expansion of the frames.

5.4.1. Mounting using bolt holes

Use fasteners to fasten the modules to the mounting support structure. Modules should be bolted to support structures through mounting holes located in the frame's back flanges only. Stainless-steel bolts, with nuts, washers, and locks washers, are recommended for module mounting. Creation of additional holes for mounting is not recommended and will invalidate the warranty.

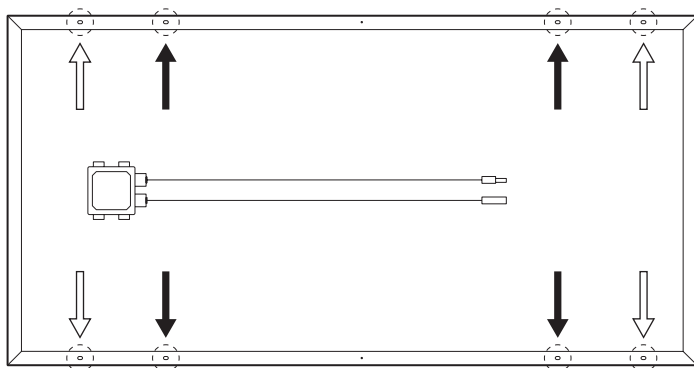

Mounting holes for normal installation



For high wind and snow-loads, these mounting holes must also be used

5.4.2. Mounting using “clamping method” and profile insert

The solar modules are suitable for installation both with their long side up and their short side up. Each module must be securely fastened at a minimum of 4 points on two opposite sides.

When installing inter-modules or end type clamps, take measures so as:

- Not to bend the module frame;
- Not to touch or cast shadow on the front glass;
- Not to damage the surface of the frame;
- To ensure the clamps overlap the module frame by at least 5 mm;
- To ensure the clamps overlap length is at least 50 mm.

Clamp material should be anodized aluminum alloy.

Clamp positions are of crucial importance for the reliability of the installation, the clamp centerlines must only be positioned within the clamping area indicated in table.

For configurations where the mounting rails run parallel to the clamps installation side, precautions should be taken to ensure the module frame (C-shape) overlap the rail by 15 mm or more.

Installation with clamps – FULL-CELL

Clamping area long side

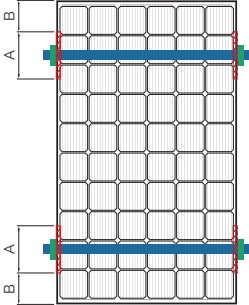

Clamping area short side

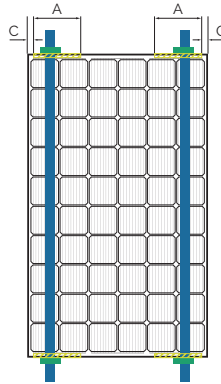

Clamping Area Approved up to 5400Pa

Clamping Area Approved up to 2400Pa

Clamps

Substructure

MODEL 60 CELLS* (6x10)

A = 250 mm

B = 170 mm

C = 35 mm

MODEL 66 CELLS* (6x11)

A = 250 mm

B = 250 mm

C = 35 mm

MODEL 72 CELLS* (6x12)

A = 250 mm

B = 328 mm

C = 35 mm

*Cells from 156x156 to 166x166mm

Installation with clamps – HALF-CELL

Clamping area long side

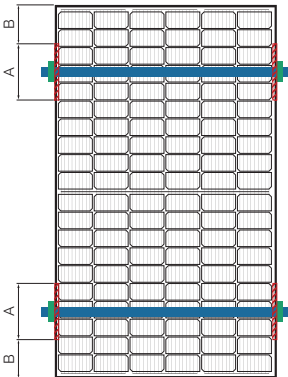

Clamping area short side

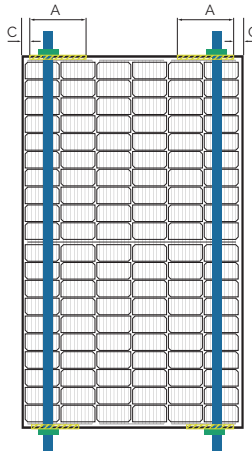

Clamping Area Approved up to 5400Pa

Clamping Area Approved up to 2400Pa

Clamps

Substructure

MODEL 108 CELLS* (6x18)

A = 250 mm

B = 170 mm

C = 35 mm

MODEL 120 CELLS* (6x20)

A = 250 mm

B = 170 mm

C = 35 mm

MODEL 132 CELLS* (6x22)

A = 250 mm

B = 328 mm

C = 35 mm

MODEL 144 CELLS** (6x24)

A = 250 mm

B = 328 mm

C = 35 mm

* Cells from 156x78 to 182x91mm

** Cells from 156x78 to 166x83mm

Installation with clamps – HALF-CELL

Clamping area long side

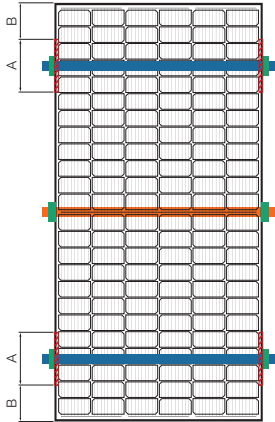

Clamping area short side

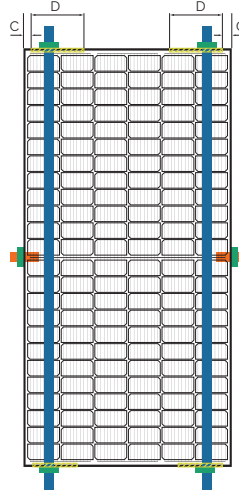

- Clamping Area Approved up to 5400Pa
- Clamping Area Approved up to 2400Pa
- Clamps
- Substructure
- Additional substructure, highly recommended

MODEL 144 CELLS* (6x24)

A = 70 mm
B = 520 mm
C = 35 mm
D = 250 mm

* Cells 182x91mm

Installation of additional central substructure is strongly recommended for applications where extreme loading conditions may occur (for example, high snow loads)

Installation with profile insert – FULL-CELL and HALF-CELL

Profile insert short side

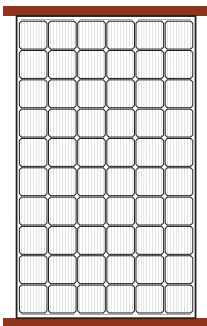

Profile insert long side

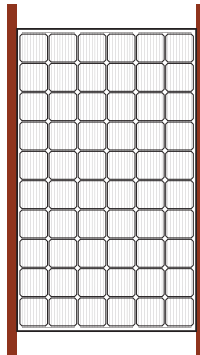

- Profile insert

LONG SIDE

Approved up to 5400Pa

SHORT SIDE

Approved up to 2400Pa

6. Electrical Installation

6.1. Blocking diodes

Blocking diodes can prevent nighttime battery discharging caused and prevent modules from loss of array output and being damaged or destroyed by reverse current flow.

Blocking diodes should be installed in series with each module or series string to prevent possible back flow of energy through the module(s) when modules or strings are connected in parallel or used in conjunction with a battery.

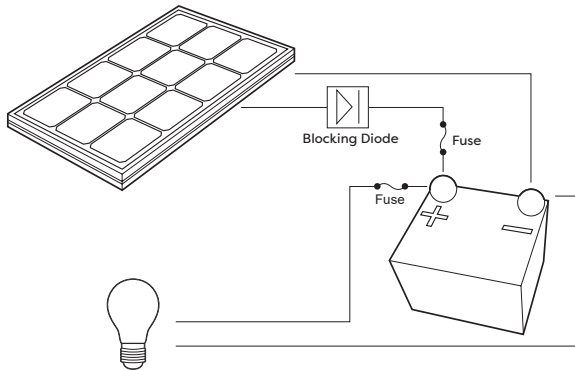

6.2. Over current protection

Whenever necessary to comply with local codes, use a fuse or circuit breaker, rated for the maximum series fuse rating of the module and the system voltage. Always fuse the connections at the battery for safety. Refer to the module rating label (on module) for recommended fuse size. Also, refer to the charge controller owners manual.

All electrical components should have ratings equal or greater to the system rating. Do not exceed the maximum allowable system voltage as listed on the module label.

6.3 Grounding

All module frames should be grounded for safety. The support structure must also be grounded unless they are mechanically connected by nut and bolts to the grounded modules.

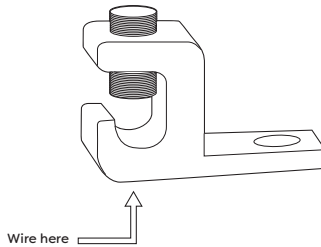

Attach a separate ground wire to grounding holes on modules frame with a self tapping screw. Module frame is provided with grounding holes. Stainless-steel bolts, with nuts, washers, and locks washers, are recommended for module grounding. The ground wire should be at least the same size as the electrical conductors, ground wires greater than 10AWG is recommended.

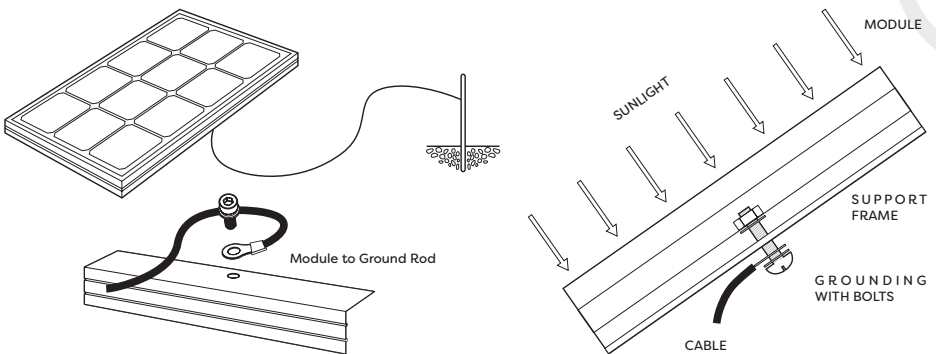

Assemble the recommended grounding lug to the Aluminum frame using stainless steel M3, M4 or M5 screw and hardware as shown below. Note: there are two different size grounding holes, the smaller of which is being phased out. Further, build up of hardware for mounting the grounding lug are the same—except for the M3 & M4 screw, and added flat washer is mounted directly under the M3 & M4 screw head. The star washer is fitted directly under the grounding lug and

makes electrical contact by penetrating the anodized coating of the Aluminum frame. The screw assembly is further fitted with a flat washer, then a split lock washer and finally a nut to secure the entire assembly, as shown. Recommended torque of M3, M4 or M5 screw assembly is 0.8NM or 1.5NM.

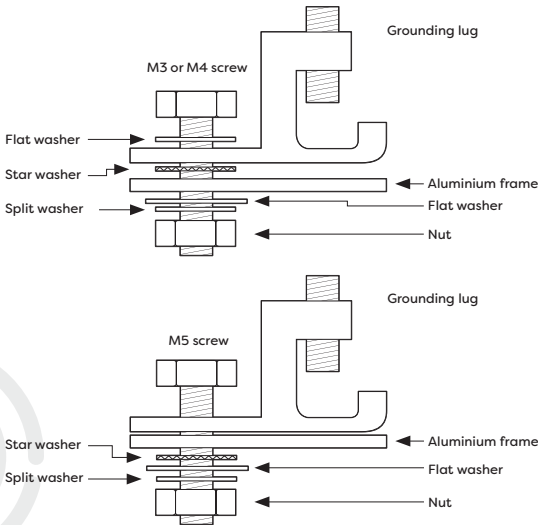

For module with \varnothing 5.1 mm grounding holes

6.4. Wiring

Modules are equipped with factory installed wires and quick connectors. Modules have been designed to be easily interconnected in series.

One module has a pair of male and female waterproof cables and connectors for electrical connection, that are pre-wired inside the junction box. The cables have obvious marks of the positive and the negative. The maximum number of modules connected in series must not exceed the maximum system voltage stated on datasheet.

The connectors at the opposite end of these wires allow easy series connection of adjacent modules by firmly inserting the male connector of a module into the female connector of an adjacent module until the connector is fully seated.

For a series electrical connection, should connect positive (+) connector of the first module to the negative (-) connector of the following module. For a parallel electrical connection, should connect positive (+) connector of the first module to

the positive (+) connector of the following module.

The cable typically used to interconnect the modules should be stranded or solid copper single-conductor type, rated sunlight resistant, for modules and module wiring that is exposed to weather, from 12AWG (4.0mm²) up to 14AWG(2.5mm²) gauge copper wire.

The maximum and minimum diameters of the cable that may be used with the cable connector are 8mm and 6mm respectively. A separate return wire or wires may be required to run the positive and negative terminations of the series string of modules to the load. Male and/or female connectors pre-attached to wires may be used at the string terminations for return wire connections and/or for source circuit box terminations. Modules have bypass diode(s) installed..

7. Maintenance

It is not uncommon for a remote site to be checked but once per year. Under most conditions, normal rainfall is sufficient to keep the module glass clean.

Clean the glass with a soft cloth using mild detergent and water. Modules that are mounted, flat (0°tilt angle) should be cleaned more often, as they will not self-clean as effectively as modules mounted at a 15°tilt or greater.

It is advisable to perform periodic inspection of the modules for damage to glass, backsheet, frame and support structure. Check electrical connections for loose connections and corrosion. Check if mounting support structure and modules are loose. Check connections of cables, connectors, and grounding. Change modules must be the same kind and type, if need. Modules can operate effectively without ever being washed, although removal of dirt from the front glass can increase output. The glass can be washed with a wet sponge or cloth, wear rubber gloves for electrical insulation.

8. Safety Precautions

Module installation and operation should be performed by qualified personnel only. Children should not be allowed near the solar electric installation.

Avoid electrical hazards when installing, wiring, operating and maintaining the module. Modules produce DC electricity when exposed to light and therefore can produce an electrical shock or burn. Modules produce voltage even when not connected to an electrical circuit or load. Modules produce nearly full voltage when exposed to as little as 5% of full sunlight and both current and power increase with light intensity. Do not touch live parts of cables and connectors. As

an added precaution, use insulated tools and rubber gloves when working with modules in sunlight.

Fall of modules from high place will cause death, injury or damage. Do not drop module or allow objects to fall on module, never leave a module unsupported or unsecured. If a module should fail, the glass can break a module with broken glass cannot be repaired and must not be used.

When installing or working with module or wiring, cover module face completely with opaque material to halt production of electricity. Modules have no on/off switch. Modules when exposed to sunlight generate high voltage and are dangerous, modules can be rendered inoperative only by removing them from sunlight, or by fully covering the front surface with opaque cloth, cardboard, or other completely opaque material, or by working with modules face down on a smooth, flat surface when installing or maintaining.

Do not artificially concentrate sunlight on the module.

Modules can produce higher output than the rated specifications. Industry standard ratings are made at conditions of 1000W/m² and 25°C cell temperature. Reflection from snow or water can increase sunlight and therefore boost current and power. In addition, colder temperatures can substantially increase voltage and power.

Modules are intended for use in terrestrial applications only, thus excluding aerospace or maritime conditions or use with sunlight concentration.

It is recommended that the module remains packed in the box until time of installation.

Work only under dry conditions, with a dry module and tools, since sparks may be produced, do not install module where flammable gases or vapors are present.

Do not drill holes into module frame as it will void warranty. Modules are constructed frame as it will void warranty.

Handled with care, if the front glass is broken or if the polymer backsheet is torn, contact with any module surface or the frame can produce electrical shock. Particularly when the module is wet, broken or damaged modules must be disposed of properly. Do not disassemble, bend, impact by sharp objects, walk on, and throw or drop etc. keep back surface free from foreign objects.

Avoid sharp edges.

Use module for its intended function only follows all module manufacturers' instructions. Do not disassemble the module, or remove any part or label installed by the manufacturer. Do not treat the back of the module with paint or adhesives. If not otherwise specified, it is recommended that requirements of the latest local, national or regional electrical codes be followed.

Retain this installation manual for future reference.

9. Disposal



The crossed-out wheeled bin symbol on the product or accompanying documents indicates that the product should not be discarded as unsorted waste but must be sent to separate collection facilities for recovery and recycling.

Please contact your local authority for details about your nearest designated collection point.

Alternatively, in some countries, you may be able to return your products to your local retailer upon purchase of an equivalent new product.

Adequate waste sorting, recycling, treatment and environmentally compatible disposal helps to avoid possible negative effects on the environment and health and favors the reuse and / or recycling of the materials of which it is composed the equipment. Illegal disposal of the product by the user involves the application of the penalties provided for in the current legislation.

10. Notes

The electrical characteristics are within ± 5 percent of the indicated values of I_{sc} , V_{oc} , and P_{max} under standard test conditions (irradiance of $100\text{mW}/\text{cm}^2$, AM 1.5 spectrum, and a cell temperature of 25°C (77°F)).

Under normal conditions, a photovoltaic module is likely to experience conditions that produce more current and/or voltage than reported at standard test conditions. Accordingly, the values of I_{sc} and V_{oc} marked on this module should be multiplied by a factor of 1.25 when determining component voltage ratings, conductor capacities, fuse sizes, and size of controls connected to the PV output. If any provision of this Limited Warranty is held invalid, unenforceable or contrary to law then the validity of the remaining provisions of this Limited Warranty shall remain in full force and effect.



info@solarcall.com | www.solarcall.com